

5 67 263 0

## Basis Surfbrett







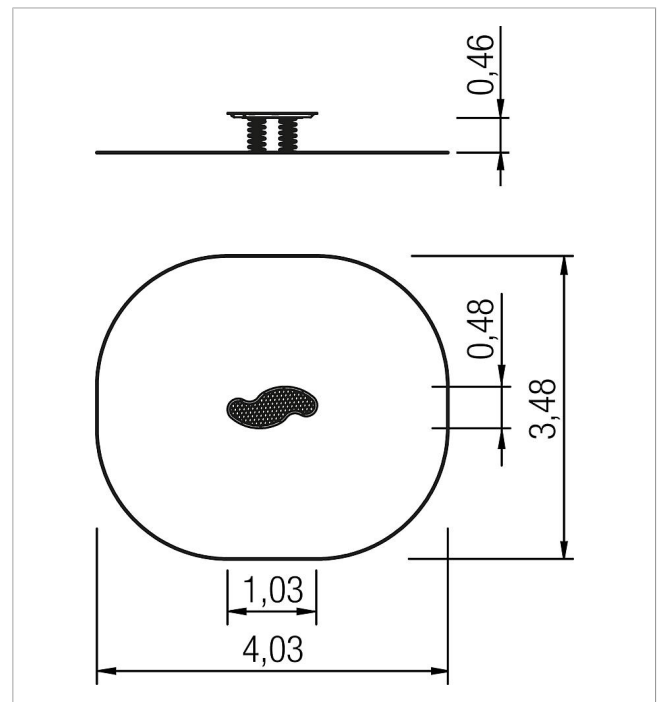

made in germany



### Lieferumfang

1x Surfbrett: Edelstahl, Hochdrucklaminat (HPL)  
2x Feder: Federstahl



	Material	Edelstahl, HPL
	Fundamentlevel	ET 500
	Mindest-Raum	4,03x3,48x2,26 m
	Freie Fallhöhe	46 cm
	Fallschutz netto	13,0 m <sup>2</sup>
	Fundamente	1x OF
	Größtes Teil	103 cm
	Schwerstes Teil	25 kg