

5 55 275 024

unique Seilbahn Fjäll 20 m







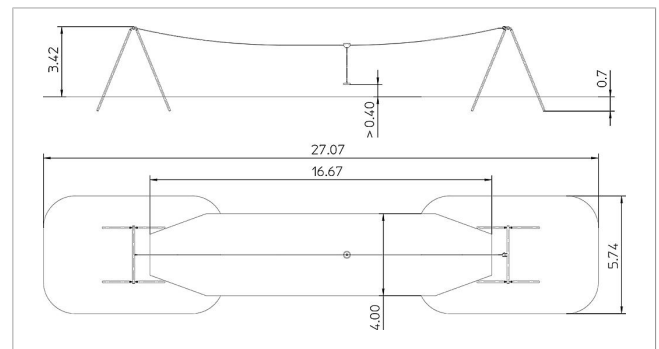

made in germany



Lieferumfang

- 1x Seilanker: Stahl feuerverzinkt
- 1x Seilspannvorrichtung: Stahl feuerverzinkt
- 1x Seilbahnwagen: Edelstahl
- 1x Tragseil L 20 m: Stahlseil
- 2x Auflauffeder: Federstahl
- 1x Pendelsitz: Gummi
- Grundkonstruktion: Stahl feuerverzinkt und pulverbeschichtet



	Material	Stahl Pulver
	Fundamentlevel	ET 800
	Mindest-Raum	24,05x4,00x4,34 m
	Freie Fallhöhe	80 cm
	Fallschutz netto	72,0 m ²
	Fundamente	8x OF
	Montage	2 Personen/5 Std.
	Größtes Teil	Ø 9x450 cm
	Schwerstes Teil	60 kg